

# Mobile Printer SM-S200 SERIES

Models: SM-S201  
SM-S202

## *Hardware Manual*

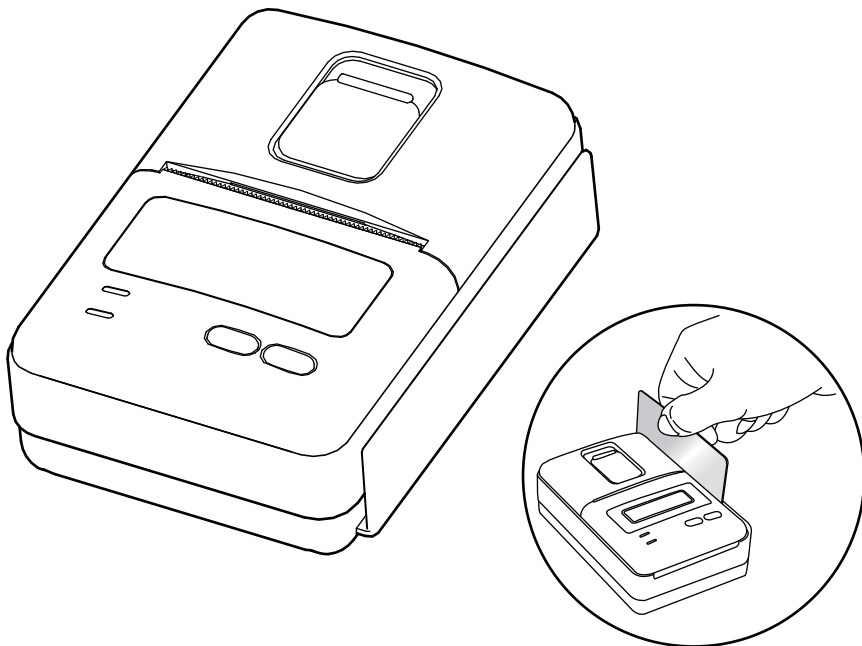

**star** 

## <USA model>

### Federal Communications Commission Radio Frequency Interference Statement

This device complies with Part 15 of the FCC Rules. Operation is subject to the following two conditions:

(1) This device may not cause harmful interference, and (2) this device must accept any interference received, including interference that may cause undesired operation.

**CAUTION:** Changes or modifications not expressly approved by the party responsible for compliance could void the user's authority to operate the equipment.

**Note:** This equipment has been tested and found to comply with the limits for a Class B digital device, pursuant to part 15 of the FCC Rules. These limits are designed to provide reasonable protection against harmful interference in a residential installation. This equipment generates, uses and can radiate radio frequency energy and, if not installed and used in accordance with the instructions, may cause harmful interference to radio communications. However, there is no guarantee that interference will not occur in a particular installation. If this equipment does cause harmful interference to radio or television reception, which can be determined by turning the equipment off and on, the user is encouraged to try to correct the interference by one or more of the following measures:

- Reorient or relocate the receiving antenna.
- Increase the separation between the equipment and receiver.
- Connect the equipment into an outlet on a circuit different from that to which the receiver is connected.
- Consult the dealer or an experienced radio/TV technician for help.

Modifications not expressly approved by the manufacturer could void the user's authority to operate the equipment under FCC rules.

This transmitter must not be co-located or operated in conjunction with any other antenna or transmitter.

This equipment complies with FCC radiation exposure limits set forth for uncontrolled equipment and meets the FCC radio frequency (RF) Exposure Guidelines in Supplement C to OET65. This equipment has very low levels of RF energy that it is deemed to comply without testing of specific absorption ratio (SAR).

## FCC WARNING

Changes or modifications not expressly approved by the party responsible for compliance could void the user's authority to operate the equipment.

For compliance with the Federal Noise Interference Standard, this equipment requires a shielded cable.

For RF interference suppression, if a ferrite core is provided with this device, affix it to the interface cable.

*The above statement applies only to equipments marketed in U.S.A.*

## <Europe model>

English: Hereby, STAR MICRONICS CO.,LTD. declares that this Wireless Device is in compliance with the essential requirements and other relevant provisions of Directive 1999/5/EC

Deutsch: Hiermit erklärt STAR MICRONICS CO.,LTD., dass sich das Gerät Wireless Device in Übereinstimmung mit den grundlegenden Anforderungen und den übrigen einschlägigen Bestimmungen der Richtlinie 1999/5/EG befindet.

Svenska: Härmed intygar STAR MICRONICS CO.,LTD. att denna Wireless Device står i överensstämmelse med de väsentliga egenskapskrav och övriga relevanta bestämmelser som framgår av direktiv 1999/5/EG.

Español: Por medio de la presente STAR MICRONICS CO.,LTD. declara que el Wireless Device cumple con los requisitos esenciales y cualesquiera otras disposiciones aplicables o exigibles de la Directiva 1999/5/CE.

Português: STAR MICRONICS CO.,LTD. declara que este Wireless Device está conforme com os requisitos essenciais e outras disposições da Directiva 1999/5/CE.

Français: Par la présente STAR MICRONICS CO.,LTD. déclare que l'appareil Wireless Device est conforme aux exigences essentielles et aux autres dispositions pertinentes de la directive 1999/5/CE.

Suomi: STAR MICRONICS CO.,LTD. vakuuttaa täten että Wireless Device tyyppinen laite on direktiivin 1999/5/EY oleellisten vaatimusten ja sitä koskevien direktiivin muiden ehtojen mukainen.

Italiano: Con la presente STAR MICRONICS CO.,LTD. dichiara che questo Wireless Device è conforme ai requisiti essenziali ed alle altre disposizioni pertinenti stabilite dalla direttiva 1999/5/CE.

Dansk: Undertegnede STAR MICRONICS CO.,LTD. erklærer herved, at følgende udstyr Wireless Device overholder de væsentlige krav og øvrige relevante krav i direktiv 1999/5/EF.

Nederlands: Hierbij verklaart STAR MICRONICS CO.,LTD. dat het toestel Wireless Device in overeenstemming is met de essentiële eisen en de andere relevante bepalingen van richtlijn 1999/5/EG

**Eesti:** Käesolevaga kinnitab STAR MICRONICS CO.,LTD. seadme Wireless Device vastavust direktiivi 1999/5/EÜ põhinõuetele ja nimetatud direktiivist tulenevatele teistele asjakohastele sätetele.  
**[Estonian]**

**Ελληνική:** ΜΕ ΤΗΝ ΠΑΡΟΥΣΑ STAR MICRONICS CO.,LTD. ΔΗΛΩΝΕΙ ΟΤΙ Wireless Device ΣΥΜΜΟΡΦΩΝΕΤΑΙ ΠΡΟΣ ΤΙΣ ΟΥΣΙΩΔΕΙΣ  
**[Greek]** ΑΠΑΙΤΗΣΕΙΣ ΚΑΙ ΤΙΣ ΛΟΙΠΕΣ ΣΧΕΤΙΚΕΣ ΔΙΑΤΑΞΕΙΣ ΤΗΣ ΟΔΗΓΙΑΣ 1999/5/ΕΚ.

**Slovensky:** STAR MICRONICS CO.,LTD. týmto vyhlasuje, že Wireless Device spĺňa základné požiadavky a všetky príslušné ustanovenia  
**[Slovak]** Smernice 1999/5/ES.

**Slovensko:** STAR MICRONICS CO.,LTD. izjavlja, da je ta Wireless Device v skladu z bistvenimi zahtevami in ostalimi relevantnimi  
**[Slovenian]** določili direktive 1999/5/ES.

**Česky:** STAR MICRONICS CO.,LTD. tímto prohlašuje, že tento Wireless Device je ve shodě se základními požadavky a dalšími  
**[Czech]** příslušnými ustanoveními smernice 1999/5/ES.

**Magyar:** Alulírott, STAR MICRONICS CO.,LTD. nyilatkozom, hogy a Wireless Device megfelel a vonatkozó alapvető  
**[Hungarian]** követelményeknek és az 1999/5/EC irányelv egyéb előírásainak.

**Български:** това Безжично устройство е в съответствие със задължителните изисквания и другите приложими разпоредби на  
**[Bulgarian]** Директива 1999/5/EC.

**Polски:** Niniejszym STAR MICRONICS CO.,LTD. oświadczam, że Wireless Device jest zgodny z zasadniczymi wymogami oraz  
**[Polish]** pozostałymi stosownymi postanowieniami Dyrektywy 1999/5/EC.

**Malti:** Hawnhekk, STAR MICRONICS CO.,LTD., jiddikjara li dan Wireless Device jikkonforma mal-ħtiġijiet essenzjali u ma  
**[Maltese]** provvedimenti oħrajn relevanti li hemm fid-Dirrettiva 1999/5/EC.

**Latviski:** Ar šo STAR MICRONICS CO.,LTD. deklarē, ka Wireless Device atbilst Direktīvas 1999/5/EK būtiskajām prasībām un citiem  
**[Latvian]** ar to saistītajiem noteikumiem.

**Lietuvių:** Šiuo STAR MICRONICS CO.,LTD. deklaruoja, kad šis Wireless Device atitinka esminius reikalavimus ir kitas 1999/5/EB  
**[Lithuanian]** Direktyvos nuostatas.

**Norsk:** STAR MICRONICS CO.,LTD. erklærer herved at utstyret Wireless Device er i samsvar med de grunnleggende krav og  
**[Norwegian]** øvrige relevante krav i direktiv 1999/5/EF.

**Íslenska:** Hér með lýsir STAR MICRONICS CO.,LTD. yfir því að Wireless Device er í samræmi við grunnkröfur og aðrar kröfur, sem  
**[Icelandic]** gerðar eru í tilskipun 1999/5/EC.

This is a class B product. In a domestic environment, this product may cause radio interference, in which case the user may be required to take adequate measures.

**Notice:** This device can be operated in all European countries.

**France:** Outdoor use limited to 10 mW e.i.r.p. within the band 2454-2483.5 MHz.  
(The wireless output power of this printer is less than 10mW e.i.r.p.)

**Italy:** For private use, a general authorisation is required if WAS/RLAN's are used outside own premises. For public use, a general authorisation is required.

**Norway:** This subsection does not apply for the geographical area within a radius of 20 km from the centre of Ny-Ålesund.

## **Trademark acknowledgments**

**SM-S200:** Star Micronics Co., Ltd.

## **Notice**

- All rights reserved. Reproduction of any part of this manual in any form whatsoever, without STAR's express permission is forbidden.
- The contents of this manual are subject to change without notice.
- All efforts have been made to ensure the accuracy of the contents of this manual at the time of going to press. However, should any errors be detected, STAR would greatly appreciate being informed of them.
- The above notwithstanding, STAR can assume no responsibility for any errors in this manual.

# Operating Precautions

Please follow the precautions below to enjoy and maintain the full performance of the printer.

## ■ Using the Printer

- Some semiconductor devices are easily damaged by static electricity. You should turn the printer “OFF”, before you connect or removed the cable on the rear side, in order to guard the printer against the static electricity. If the printer is damaged by the static electricity, you should turn the printer “OFF”.
- Be careful not to drop or bump the printer on a hard surface.
- Do not install the printer in direct sunlight or such areas.  
Suitable environment for the use of the printer is as follows:  
Operating temperature :0 °C to 50 °C  
Relative humidity : 30 % to 80 % (No condensation)
- Do not install the printer near devices that generate strong electromagnetic fields such as a copy machine.
- Do not open the paper cover during printing.
- Before opening the paper cover, ensure no data is being sent to the printer and turn off the power.
- Do not remove or reinstall the communication cable during printing or transmission.
- Do not touch the connectors of the communication during printing.
- Switch the POWER OFF when not in use.
- Do not use alcohol or other solvent.
- The battery charger and the battery pack may become warm when in use. This is normal and is not a malfunction.
- When the battery pack is used at low temperature, the length of time the printer can be used may be shortened.
- Use only the power cord supplied in the package.

## ■ Thermal Paper Handling

- Store the thermal paper in a cool, dry and dark place.
- Do not rub the paper with hard object.
- Do not leave the paper with hard object.
- Do not allow plastic film, erasers, or adhesive tape to touch the paper for long periods.
- Do not stack the thermal paper with diazo copies immediately after copying or wet-type copies.
- Do not use chemical glue.
- Always use the clean thermal paper.

## Choosing a Place for the Printer

Before actually unpacking the printer, you should take a few minutes to think about where you plan to use it. Remember the following points when doing this.

- ✓ Choose a firm, level surface where the printer will not be exposed to vibration.
- ✓ The power outlet you plan to connect to for power should be nearby and unobstructed.
- ✓ Make sure that the printer is close enough to your host computer for you to connect the two.
- ✓ Make sure that the printer is not exposed to direct sunlight.
- ✓ Make sure that the printer is well away from heaters and other sources of extreme heat.
- ✓ Make sure that the surrounding area is clean, dry, and free of dust.
- ✓ Make sure that the printer is connected to a reliable power outlet. It should not be on the same electric circuit as copiers, refrigerators, or other appliances that cause power spikes.
- ✓ Make sure that the room where you are using the printer is not too humid.

### **WARNING**

- ✓ Shut down your equipment immediately if it produces smoke, a strange odor, or unusual noise. Immediately unplug the equipment and contact your dealer for advice.
- ✓ Never attempt to repair this product yourself. Improper repair work can be dangerous.
- ✓ Never disassemble or modify this product. Tampering with this product may result in injury, fire, or electric shock.

# Table of Contents

<b>1. Introduction.....</b>	<b>5</b>
<b>2. Setting up the printer .....</b>	<b>6</b>
2.1. Printer & Accessories .....	6
2.2. Printer Features .....	7
2.3. Replacing Paper Roll .....	8
2.4. Power Supply .....	10
2.4.1. Specified Power Supply .....	10
2.4.2. Installing the Battery .....	10
2.4.3. Recharging the Battery Pack .....	10
2.5. Memory Switch Settings .....	12
<b>3. Interface.....</b>	<b>15</b>
3.1. RS-232C .....	15
3.2. Bluetooth.....	16
<b>4. Using the Printer.....</b>	<b>17</b>
4.1. Control Panel .....	17
4.2. The self Test.....	18
4.3. Instruction for Auto Power Down Mode.....	18
<b>5. Consumable Parts .....</b>	<b>19</b>
5.1. Paper Roll Specifications .....	19
5.2. Recommended Thermal Paper Roll.....	19
5.3. Printing Position .....	19
<b>6. Specifications .....</b>	<b>20</b>

# 1. Introduction

This printer is the ideal solution for Mobile banking system , Retail, point of sales, Credit card Transaction, other traveling and mobile computing etc.

The general features of this printer are as follows:

- Pocket size (80 × 112 × 46 mm)
- Light weight (232 g) for true mobility
- Very silent printing thru direct thermal printing method
- High speed (80 mm/sec, MAX)
- RS-232C, Bluetooth Ver2.1+EDR interface
- Support secure wireless communication
  - ✓ Bluetooth security mode 3 is available (PIN code 16 characters maximum)
  - ✓ Non-discoverable mode can be offered (Factory option)
- Support Magnetic Stripe Reader
- Support Graphic LCD(128 × 32 dots) with Blue LED Backlight
- Support text and graphic printing
- Bit-Image(Logo) Store Function “Use Logo Store Tool to store a logo.”
- Drop-In and Print Easy Paper Loading
- One touch paper cover
- Flow control : Software (XON/XOFF)
  - ※ Hardware flow control not supported in printer.

## 2. Setting Up the Printer

### 2.1. Printer & Accessories

Your printer box should include these items. If any items are damaged or missing, please contact your dealer for assistance.

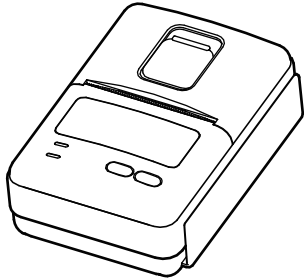

Printer

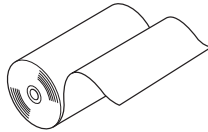

Paper

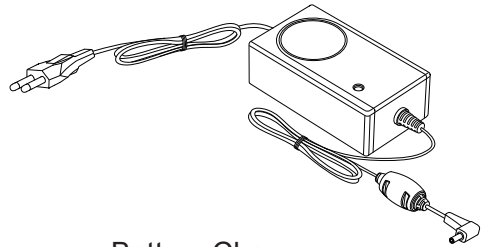

Battery Charger

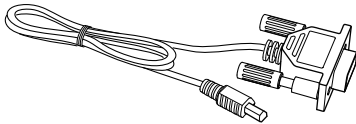

Communication Cable  
(SERIAL CABLE SM-S)

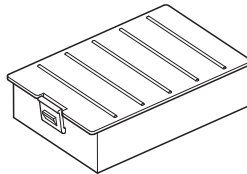

Battery Pack

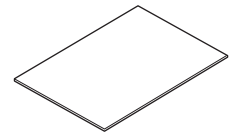

Safety Instruction Sheet

### ▼ OPTIONAL

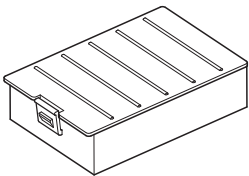

Extra Battery Pack

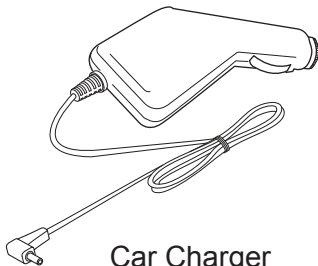

Car Charger

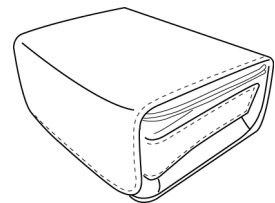

Carrying Case

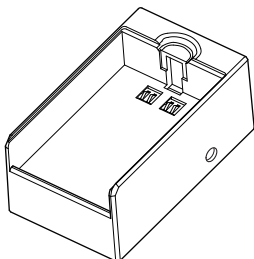

Battery Holder

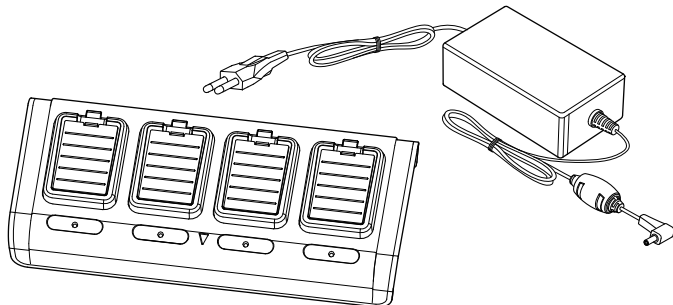

4 Unit Battery Charger (Special Battery Charger + 4 Unit Holder)



## 2.2. Printer Features

### ■ Part Name

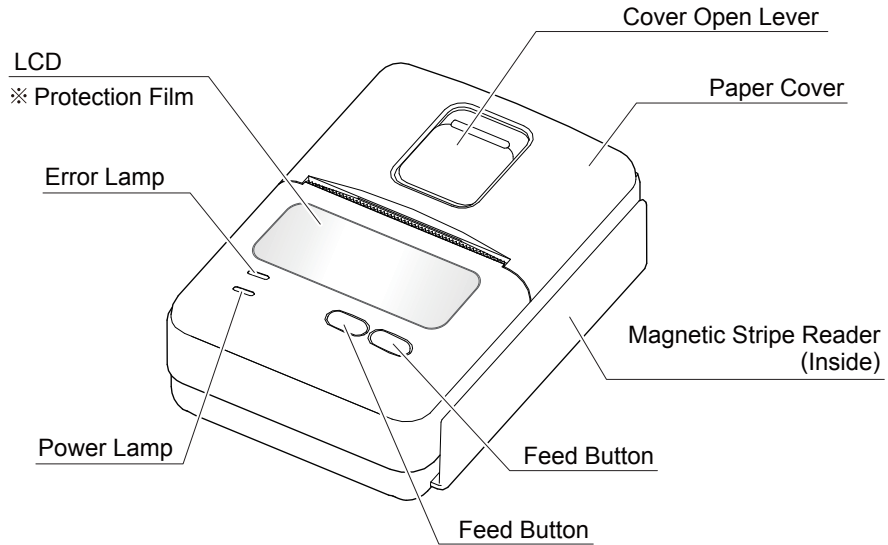

※ Remove the Protection Film, if it's not necessary.

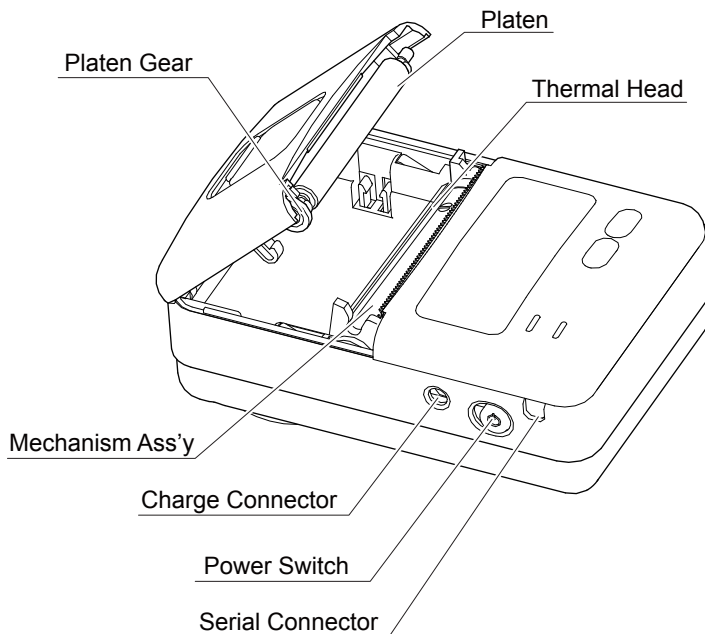

## 2.3. Replacing Paper Roll

### **Cautions :**

*Be sure to use paper rolls that meet the specifications. Do not use paper rolls that have the paper glued to the core because the printer cannot detect the paper end correctly.*

1. Before opening the paper cover, ensure no data is being sent to the printer and turn off the power.
2. Open the paper cover by placing your finger under the cover open lever and pull it up.

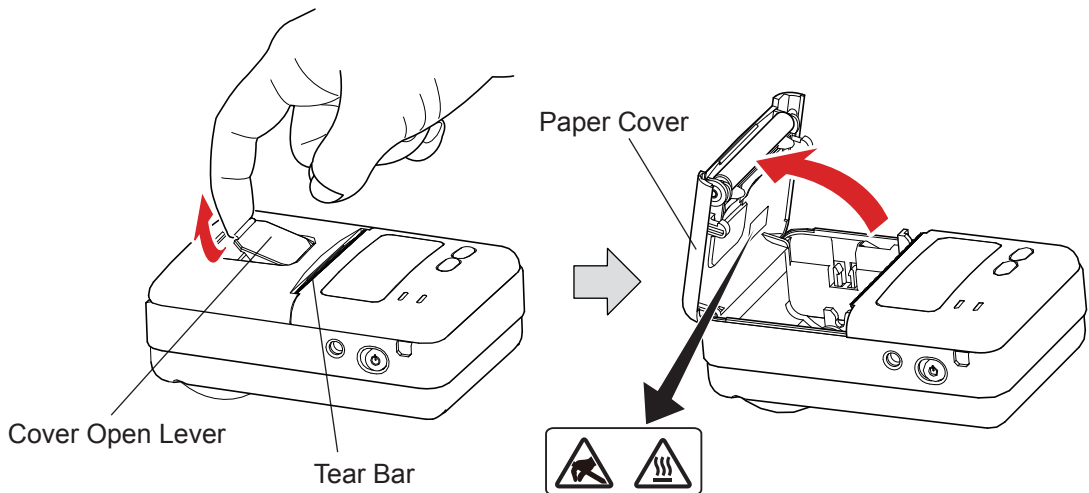

### Caution Symbol



*This symbol is placed near the thermal head to indicate that it may be hot. Never touch the thermal head immediately after the printer has been used. Let the thermal head cool for a few minutes before touching it.*

### **WARNING**

- 1) *Do not touch the tear bar.*
  - *There is a tear bar inside the paper outlet slot. Not only should you not put your hand in the paper outlet slot while printing is in progress, never put your hand into the outlet even when printing is not in progress.*
  - *The paper cover can be opened when replacing the paper. However, since the tear bar is on the inside of the paper cover, be careful not to place your face or hands too close to the tear bar.*
- 2) *During and immediately after printing, the area around the thermal head is very hot. Do not touch it, as you could be burned.*

3. Insert a new paper roll as shown.

Push down gently on both sides of the paper cover to close it.

Ensure the paper cover is securely closed.

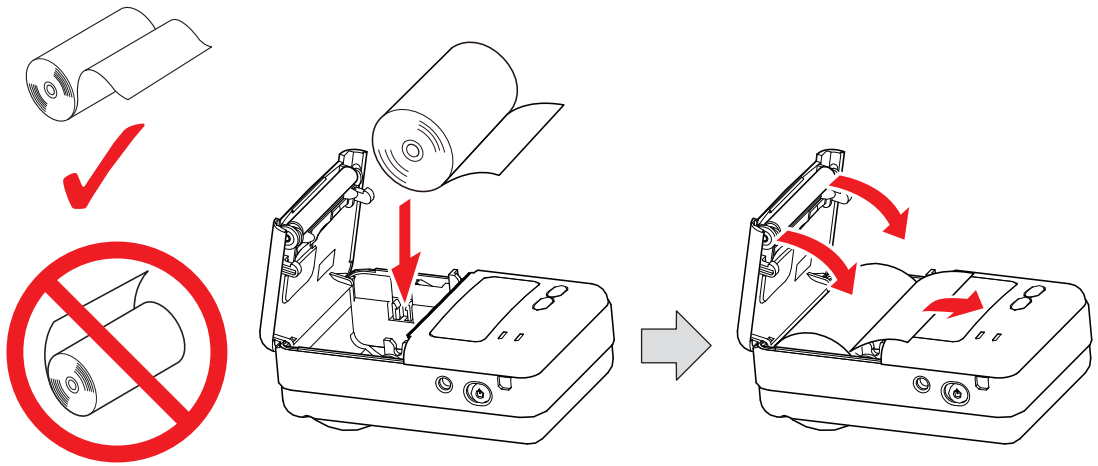

4. Tear the excess paper off using the tear bar.

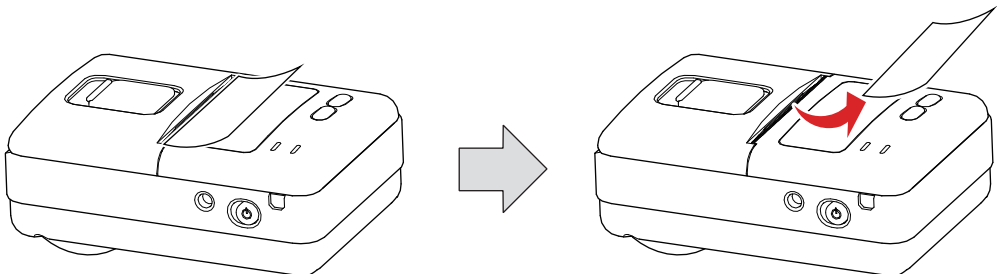

5. Turn the printer power on.

## 2.4. Power Supply

### 2.4.1. Specified Battery Charger

OUTPUT : DC 8.4 V/0.8 A (CC-CV)

### 2.4.2. Installing the Battery

#### **⚠ Cautions :**

- 1) *Before installing or removing the battery pack, ensure the printer is OFF.*
- 2) *If the printer is not used for long period of time, remove the battery pack from the printer.*

1. To install battery pack, proceed as follows:

- Insert the battery pack in the direction of the arrow.

2. Reverse the order to remove the battery pack.

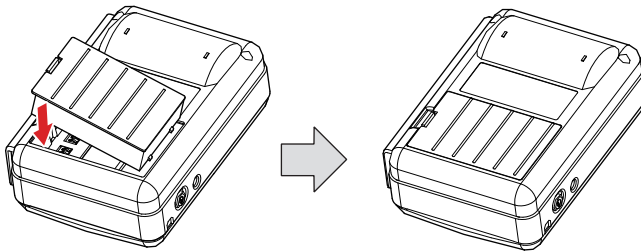

3. The battery pack install into the battery holder.

- Insert the battery pack in the direction of the arrow.

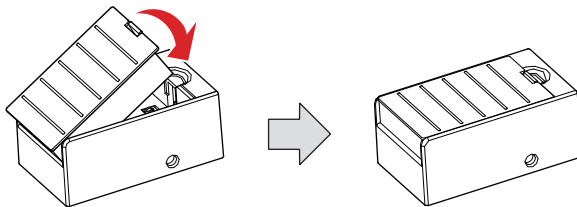

### 2.4.3. Recharging the Battery Pack

For recharging the battery pack, install the battery pack in the printer or the battery holder. Insert the Battery Charger to the charge connector of the printer or the battery holder.

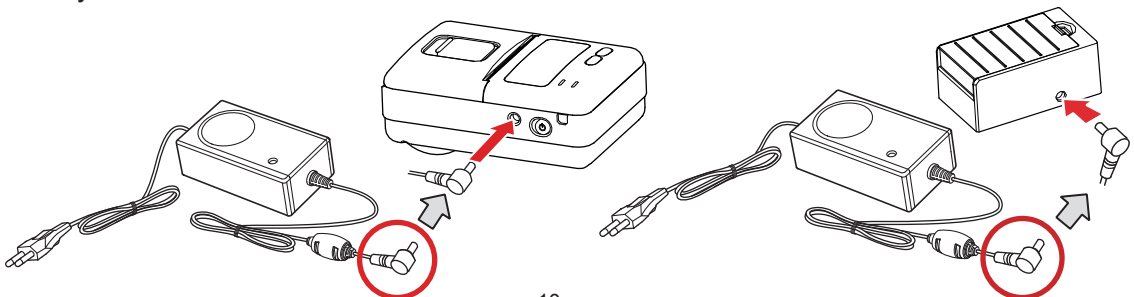

## **Cautions Concerning Batteries**

### ► **General Battery Characteristics**

- The battery is a consumable and its performance over time will gradually decrease.
- While not in use, the battery will slowly discharge itself.
- Fully charge the battery before using the printer.
- To extend battery life, it is recommended to use a smart energy management solution such as the Auto Power Down Mode available on all Star Micronics Portable Printers.
- When used at low temperatures, battery performance will temporarily decline. Be sure to have a fully-charged spare battery standing by if the printer will operate in a cold environment.

### ► **Battery Charging**

- Charge the battery in an environment with a temperature ranging from 0 °C to 40 °C.
- The time required to charge the battery depends on the voltage or ambient temperatures. The battery requires four hours of charging under normal conditions.
- Do not remove the battery while it is charging.
- The battery does not need to be fully discharged before recharging it.
- The battery may be warm after charging or use. This condition is normal and does not indicate a malfunction.
- Do not recharge the battery after it is fully charged.

### ► **Battery Life**

- The battery can be charged approximately 500 times in the normal temperature range without losing performance. If an extreme decline in the running time of the battery is noticed, the battery is reaching the end of its usable life. It is recommended to replace the old battery with a new one.

### ► **Battery Storage**

- Storing a charged battery for a long period may damage its capacity. Be sure to fully discharge the battery before storing or if it will not be used for a long period of time.
- When the battery is not in use, remove it from the printer or charger.
- Store the battery in a cool, dry place.
- Recommended Storage Temperature Range: +15 °C to +25 °C
- Avoid storing the battery in a place with extremely high or low humidity.

## 2.5. Memory Switch Settings

1. Change the Memory switch by this operation. (Refer to Table 1).

MODE button : changing Printer MODE status

FEED button : changing OPTION status.

2. [Example] The defaults of the printer are :

Bluetooth/57600 bps/8 Data bit/No Parity/1 Stop bit/Density Medium

If a user wants to change the defaults with

RS-232C/9600 bps/7 Data bit/Even Parity/2 Stop bit/Density High

▶ To put the printer into Memory Switch Setting mode, press and hold the MODE button for 5 seconds.

The ERROR lamp will flash 5 times and the LCD screen will confirm the mode has changed.

→ You will see present COMMUNICATION mode in the LCD.

→ Press the MODE button one time.

(The interface mode has set to RS-232C mode.)

Bluetooth → RS-232C

▶ Press FEED button one time.

→ You will see present BAUD RATE mode in the LCD.

Communication Port → Baud Rate

→ Press the MODE Button twice.

(The baud rate has set to 9600 bps)

57600 bps → 115200 bps → 9600 bps

▶ Press FEED button one time.

→ You will see present DATA BIT mode in the LCD.

Baud Rate → Data Bit

→ Press the MODE button one time.

(The data bit has set to 7 data bit.)

8 Data Bit → 7 Data Bit

▶ Press FEED button one time.

→ You will see present PARITY BIT mode in the LCD.

Data Bit → Parity Bit

→ Press the MODE button twice.

(The parity bit has set to even parity bit.)

No Parity → Even Parity

▶ Press FEED button one time.  
→ You will see present STOP BIT mode in the LCD.  
Parity Bit → Stop Bit  
→ Press the MODE button one time.  
(The stop bit has set to 2 stop bit.)  
1 Stop Bit → 2 Stop Bit

▶ Press FEED button one time.  
→ You will see present DENSITY mode in the LCD.  
Stop Bit → Density  
→ Press the MODE button one time.  
(The density has set to high.)  
Density Medium → Density High

If all the mode have set, press the FEED button and the MODE button at the same time after then release the buttons at the same time.

The printer will print out the mode status which has modified.  
(RS-232C/9600 bps/7 Data bit/Even Parity/2 Stop bit/Density High)

If the status is not correct, please try it again according to the procedure.

## Memory Switch Setting Table

	Printer Mode	Setting
1	Communication Port	RS-232C
		Bluetooth *
2	Baud Rate	9600 bps
		19200 bps
		38400 bps
		57600 bps *
		115200 bps
3	Data Bit	7 Data bit
		8 Data bit *
4	Parity Bit	No Parity *
		Odd Parity
		Even Parity
5	Stop Bit	1 Stop bit *
		2 Stop bit
6	Density	Density Low
		Density Medium *
		Density High
7	Print Speed	Low *
		High
8	BM Sensor	No use *
		Use
9	BM Sensor Sensitivity	Low *
		Medium 1
		Medium 2
		High
		Automatic Setting
10	Power Down	No use *
		1 Minute Sleep
		2 Minute Sleep
		3 Minute Sleep
		4 Minute Sleep
		5 Minute Sleep

\* : Default



## 3. Interface

### 3.1. RS-232C

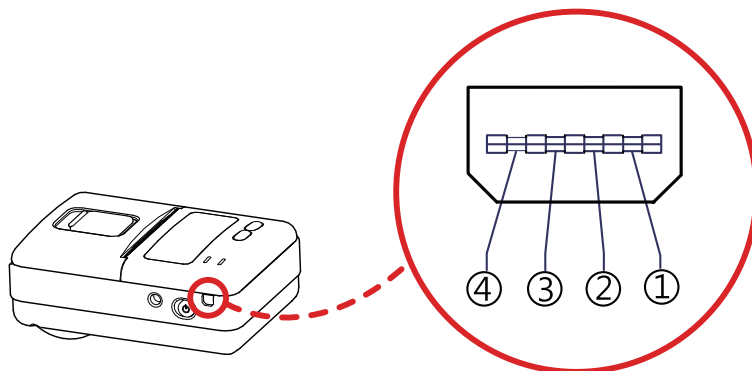

This printer has a RS-232C interface and is connected by means of a 4 pin mini USB socket. In the following table, the signals present on the Mini-USB socket are listed:

Pin No.	Name	Direction	Function
1	TxD	Output	Transmit Data
2	RxD	Input	Receive Data
3	CTS	-	-
4	GND	-	Ground

\* Applicable connector: SUNG KYUNG (CM-720)

#### **⚠ Caution :**

*When it removes the communication cable during receiving data, it loses a data.  
Don't connect USB mini B cable here.*

## 3.2. Bluetooth

Category	Specification
Bluetooth Spec.	Bluetooth V2.1+EDR / Class 2 (10 m)
Frequency Range	2.4 GHz ISM BAND
Data Transmission Rate	57600 bps Fixed
Data Bit	8 Data Bit Fixed
Parity Bit	No Parity Fixed
Stop Bit	1 Stop Bit Fixed
Support Profile	SPP (Serial Port Profile)

PIN code: 1234 as default

Device Name: Star Micronics

For example: Host OS Bluetooth detection

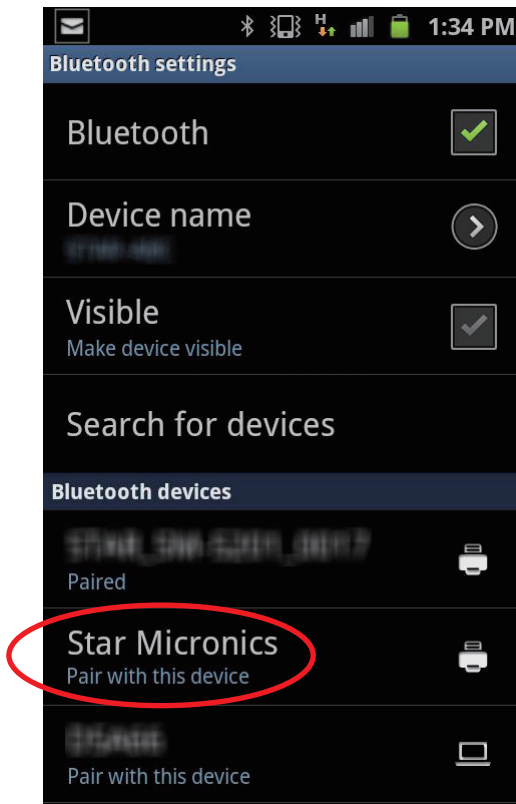

### **Caution**

- 1) If more than 1MB of data is sent to the printer over Bluetooth, the buffer will overflow and the data will be corrupted.
- 2) Star Micronics recommends changing the default PIN code to an original number for security purposes. This can be done by using the mobile security utility, available through our dealers.
- 3) Refer to the host device's manual for information on how to pair the printer with it.

## 4. Using the Printer

### 4.1. Control Panel

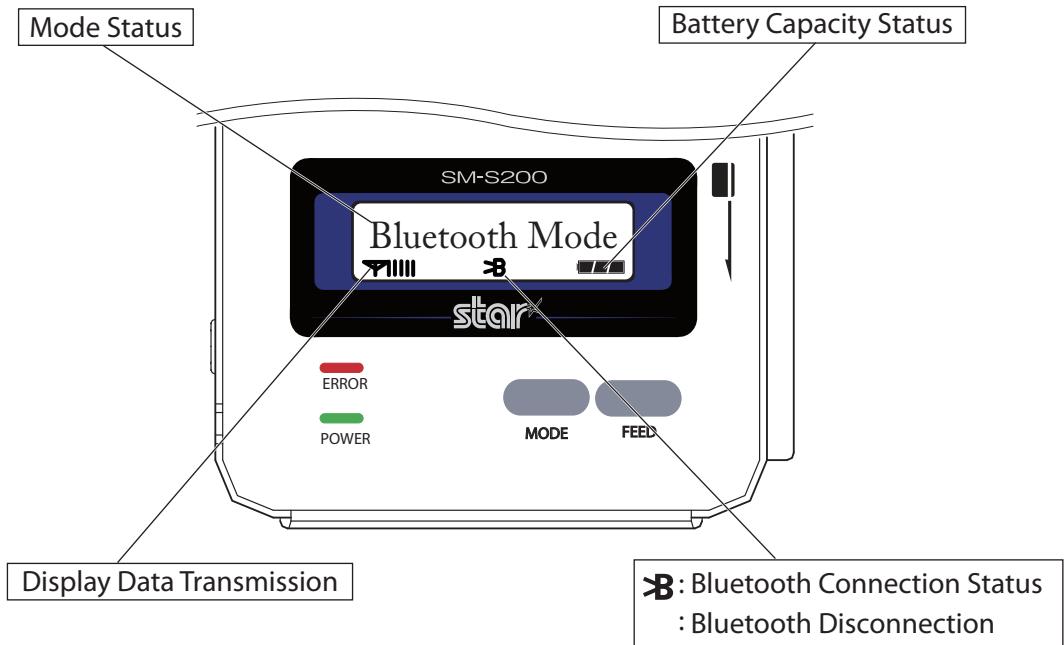

#### ► Button

##### **FEED Button :**

When the printer is on, paper can be fed manually by pressing and holding the FEED button for more than one second.

##### **MODE Button :**

Pressing and holding the MODE button will cause the ERROR lamp to flash 5 times and put the printer into Memory Switch Setting mode.

(Refer to **2.5. Memory Switch Settings** for details about mode conversion)

#### ► Panel Lamp

**ERROR (Red) :** Indicates an error has occurred.  
(Ex: Paper Out, Cover Open, etc)

**POWER (Green) :** Printer is ON and ready to receive data.

## 4.2. The Self Test

The self test procedure will check most of the printer functions.

For self test, turn on the power while holding down the FEED button.

The Self-Test checks the following :

- 1) Make sure paper roll has been installed properly.
- 2) The Self-Test prints the current printer status, which provides the control ROM version and the communication method setting.
- 3) After printing the current printer status, Self-Test will print a pattern using the built-in character set.
- 4) The Self-Test automatically ends.

The printer is ready to receive data as soon as it completed the self test.

## 4.3. Instruction for Auto Power Down Mode

The printer in the Power Down Mode will recover to the Print Ready Mode when receiving commands or button operations.

However, print data received while shifting from the Power Down Mode to the print Ready Mode (for approx. 1 sec.) is discarded and cannot be printed.

Therefore, if the printer is in the Power Down Mode, please be sure to recover it to the Print Ready Mode before sending print data.

[ How to Recover to Print Ready Mode & How to Check ]

- 1) Send the Status command (DLE EOT EOT), and Try to re-send it until receiving the transmission value which is from 30H to 37H.

Or

- 2) Press the FEED button or the MODE button (the Power button for SM-S200 series) and confirm that the Power lamp (Green LED) is turned on.

# 5. Consumable Parts

## 5.1. Paper Roll Specifications

- Type : Thermal Paper
- Paper width : 57.5±0.5 mm
- Paper thickness : 65±5  $\mu$ m
- Outer diameter : Ø39 mm or less
- Inner diameter : Ø12mm or more
- Recording side : Outside of roll

**⚠ Cautions :**

- 1) Do not paste the paper to the core. And the roll paper which has Near end mark printing on its near end is recommended.
- 2) Chemicals or oil may change the color of paper, or printed Characters may fade.
- 3) Change of paper color starts from approx 70 °C.  
Pay attention to heat, humidity and sun light.
- 4) Color of paper may be changed by being scratched by nail or hard metal, etc.

## 5.2. Recommended Thermal Paper Roll

Manufacturer	Product Name
Mitsubishi Paper Mills Limited	P220AG
Oji Paper Co., Ltd.	PD450
APPLETON	Alpha 800-2.4
KANZAKI (Oji Paper USA)	P-350

## 5.3. Printing Position

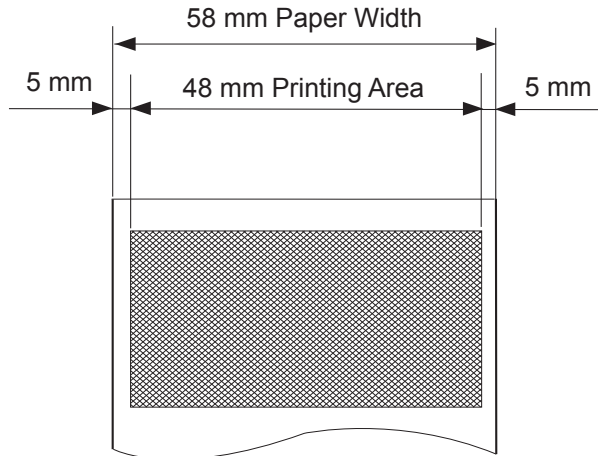

## 6. Specifications

Item	Specifications	
Print method	Direct thermal line printing	
Characters per line	42 cpl (MAX)	
Character size	Eng. : 9×24 dots, 12×24 dots, 8×16 dots	
Optional Characters	Simplified/Traditional Chinese, Arabic, Cyrillic, Russian, Turkish, Greek, Japanese, Persian, Latin9 and Others upon request.	
Resolution	203 dpi, 8 dots/mm	
Print width	2-inch (48 mm, 384 dots)	
Print speed	80 mm / sec (Max) : 50 mm / sec (Default)	
Dimension	80×112×46 mm	
Weight	232 g (Including battery pack)	
Interface	RS-232C & Bluetooth Ver 2.1 + EDR	
Paper roll	Thermal roll paper (58 mm wide, ø39)	
Barcodes	1-dimension : Code128, Code39, Interleaved 2/5, Code93, UPC, EAN, JAN, CODABAR 2-dimension : PDF417, QR Code, DATA Matrix	
H/W Spec.	MCU : 32bits RISC, FLASH : 4Mbytes, RAM : 8Mbytes	
Receive buffer size	1M bytes	
MSR	SM-S201 ISO 7810 / 7811 / 7812 1st and 2nd Track Reading SM-S202 ISO 7810 / 7811 / 7812 2nd and 3rd Track Reading	
LCD	128×32 Dots FSTN (Blue LED Backlight)	
Battery	Rechargeable 7.4V DC	
Battery duration	6 hour printing (12 receipts per hour) 9 hour printing (12 receipts per hour / auto power down mode)	
Battery charger	Input (100~250 V AC, 50~60 Hz) Output(8.4 VDC/0.8 A), 4 hours full charge time	
Environment conditions	Temperature *1)	0 °C ~ 50 °C (operating) -20 °C ~ 60 °C (storage)
	Humidity	30 % - 80 % (operating) 10 % - 90 % (storage)
TPH Life	Approximately 50 Km	
Drop resistant	1.0 m *Our test procedure, Not guarantee.	

\*1) Under 10°C, please change Density mode of the memory switch settings to “High”.

## ■ Dimensions

External Dimensions : 80 mm (width) × 112 mm (depth) × 46 mm (height)

Weight : 232 g (Including Battery Pack)

Body Color : Piano Black

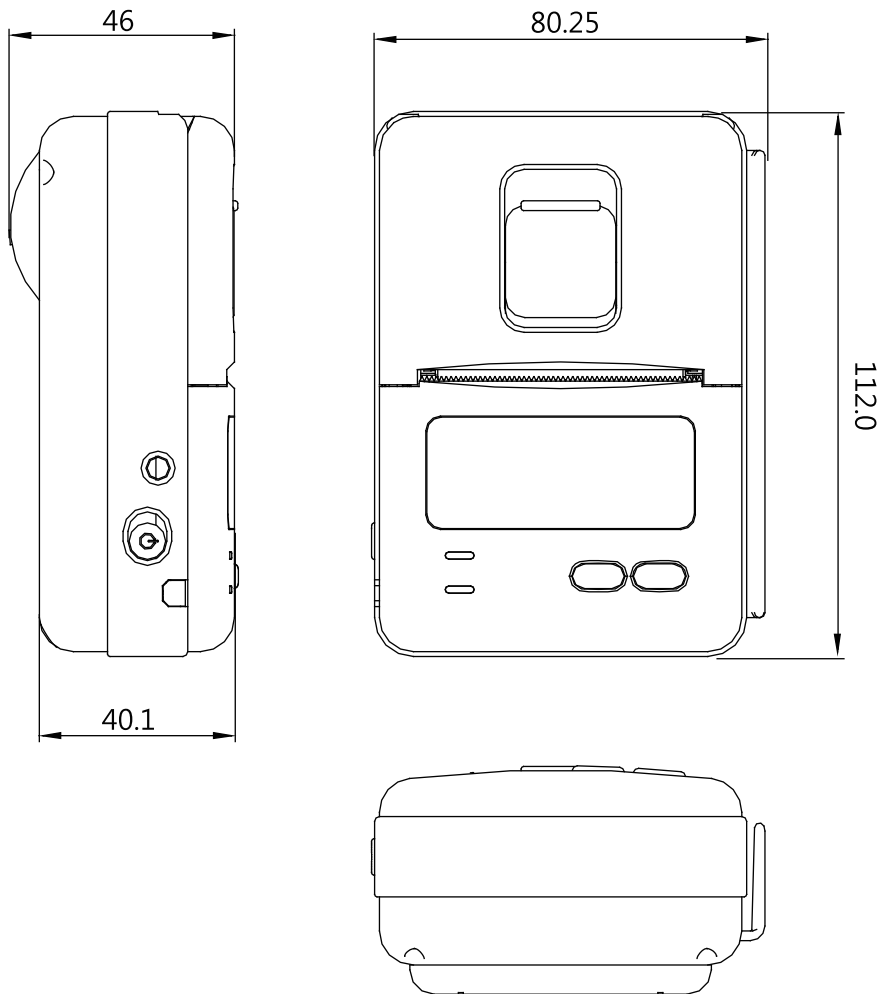

## Declaration of Conformity

Application of Council Directive(s)

**EMC 2004/108/EC of 15 Dec. 2004**  
**LV 2006/95/EC of 12 Dec. 2006**  
**R&TTE 1999/5/EC of 9 Mar. 1999**

Standard(s) to which Conformity is Declared

Radio: **EN 300 328 V1.7.1**  
**EN 50371:2002**  
EMC: **EN 301 489-1 V1.8.1**  
**EN 301 489-17 V2.1.1**  
**EN 55022:2006 (Class B)**  
**EN 55024:1998/+A1:2001 +A2:2003**  
LV : **EN60950-1:2006/+A11:2009**

Manufacturer's Name **Star Micronics Co.,Ltd.**

Manufacturer's Address **20-10 Nakayoshida, Suruga-ku, Shizuoka-shi,  
Shizuoka-ken, 422-8654, Japan**

Type of Equipment **Thermal Printer**

Model Name **PORTI-SC40N**

Ref. R&TTE Radio Report No. **ETLE100105.01, ETLE100105.01**

Ref. R&TTE EMC Report No. **ETLE100105.02**

Ref. EMC Report No. **ETLE100105.03**

Ref. Safety Report No. **ETLS100105.01**

I, the undersigned, hereby declare that the equipment specified above conforms to the above Directive(s) and Standard(s).

Place High Wycombe - U.K.

D. Pearce (Signature)

Date Jan. 24, 2011

David Pearce (Full Name)

Technical Manager (Position)





*URL: <http://www.star-m.jp/eng>*